

www.sscera.kr

SHINSUNG C&P CO.,LTD.

(주)신성씨앤피



(주) 신성씨앤피

Shin Sung

경기도 시흥시 공단2대로 318번길 3 (정왕동, 시화공단 3바 401호)

Tel. 031)432-6298/0856 Fax. 031)432-6297

E-mail. shinsung@sscpn.kr www.sscera.kr

내마모 제품의 설계/개발/시공
세라믹 정밀가공 및 내마모 플랜트 전문

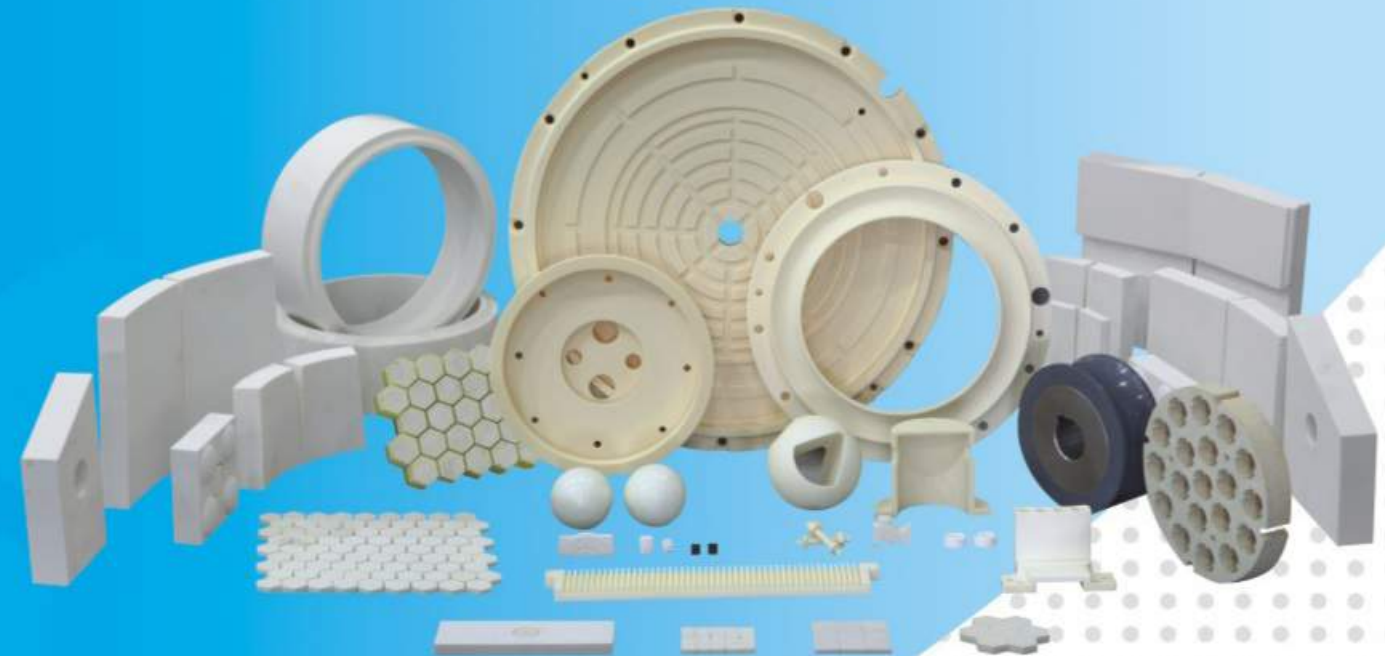

 (주) 신성씨앤피
Shin Sung



SHINSUNG C&P CO.,LTD.

We will try until the best leader in the field of ceramics for our customer's satisfaction through quality improvement and research and development.

미래가 있는 회사 (주)신성씨앤피

내마모 제품의 설계/개발/시공 세라믹 정밀가공 및 내마모 플랜트 전문

"미래가 있는회사" 라는 이념아래 (주)신성씨앤피는 1996년에 설립하였습니다.
당사는 구조세라믹용 분말프레스 제품을 시작으로 꾸준한 기술개발과 설비투자로 반도체/ LCD/ Plasma 등의 정밀가공부품의 생산 및 발전소, 제철소, 제지업계에서 필요로 하는 다양한 내마모제품을 설계, 개발 및 시공을 통하여 고객의 요구사항에 맞는 제품을 공급하기위해 노력하고 있습니다. 향후 저희 (주)신성씨앤피의 임직원들은 고객에게 더욱 높은 만족을 드리기 위해 꾸준한 품질개선 및 연구개발에 박차를 가할 것을 약속 드리며, 더 나아가 세라믹 정밀가공 및 내마모 플랜트 분야에서 최고의 선두주자가 될때까지 지속적인 관심과 격려를 부탁드립니다. 감사합니다.

In the motto of the company with future, Shin Sung C&P was established in 1996.
Starting from powder pressed products for structure ceramics, we're endless effort to provide the products meeting customers' requirements through designing, developing & constructing a variety of the high abrasive resistant products needed in power plants, steel mills, paper industry, etc as well as by producing precise grinding components for semiconductor, LCD, plasma, etc.
In the future, our staff at Shin Sung C&P Co., Ltd will our best effort to do quality improvement & spur on research and development in order to give our customers higher satisfaction. Further more, we hope your continuous deep attention & encouragement until being the leader in the field of ceramic precision machining & plant for abrasive resistance.



클래서파이어 사이클론 슈트 내 댐퍼용 세라믹 라이너 조립방법 세라믹 슈트라이너 및 제조방법 컨베이어벨트 크리닝장치 NEP인증

기술혁신형 중소기업 (INNO-BIZ) 인증 연구개발 전담부서 인증 2011년 경기도 유망중소기업 선정 ISO 9001:2008 품질경영 인증 ISO 14001:2004 환경경영 인증

정비적격업체 인증 (남동발전) 정비적격업체 인증 (남부발전) 정비적격업체 인증 (중부발전) 정비적격업체 인증 (서부발전) 정비적격업체 인증 (동서발전)

- 1996~1999
 - 1996.07 신성세라믹 창업 Shin Sung Ceramics was established
 - 구조세라믹용 알루미나 소재 생산 Production of Advanced Structural Alumina Ceramics Materials
 - 자동차용 insulator 개발 생산 Development & Production of Insulators for automobile

- 2000~2005
 - 2004.10 ISO 9001:2000 품질경영시스템 인증 ISO 9001 : 2000 certified
 - 2005.09 (주)신성세라믹 법인 전환 Converted to Shin Sung Ceramics CO., LTD.

- 2006~2010
 - 2006.01 현 주소로 확장 이전 Movement of factory of Shin Sung Ceramic inside
 - 2007.08 발전소 정비적격업체 등록 (중부, 남부, 서부, 남동, 동서) Registered as an eligible firm for maintenance - Power plant Korea Midland, Southern, Western, South-East and East-West Power
 - 2008.11 연구개발전담부서 설립 Establishment R&D team of Shin Sung Ceramics
 - 2009.03 인천영업소 설립 Establishment Incheon business office
 - 2009.11 기술혁신형 중소기업 선정(INNO-BIZ) Certified as a technology innovative small and medium company (INNO-BIZ)
 - 벤처기업 선정 Certified as a venture business

- 2011~
 - 2011.06 ISO 14001 : 2004 환경경영시스템 인증 ISO 14001 : 2004 certified
 - 2011.09 경기도 유망중소기업인증 Designated promising small and medium business company of Gyeonggi-do
 - 2012.02 NEP인증(석탄투하용 내충격성 세라믹 복합재 슈트라이너) NEP Certified (Use for coal dropping Shock-Resistant Ceramic Composites Chute Liner)

about the Ceramic⁺

We will try until the best leader in the field of ceramics for our customer's satisfaction through quality improvement and research and development.

>> 세라믹이란?

성형공정을 통해 제작되어 고온에서 구워 만든 비금속 무기질 고체 재료
 Non-metallic, inorganic substances that are manufactured through a process of molding or shaping and exposure to high temperatures

대표적인 세라믹으로

- 산화물(Oxide) : 알루미나(Al_2O_3), 지르코니아(ZrO_2), 실리카(SiO_2)
- 질화물(Nitride) : 질화규소(Si_3N_4), 질화알루미늄(AlN), 질화붕소(BN)
- 탄화물(Carbide) : 탄화규소(SiC), 탄화티탄(TiC) 등이 있다.

세라믹은 전자제품 및 기타 첨단 산업에서 사용되고, 따라서 고도의 정밀한 규격과 까다로운 성능 등의 요구 사항을 충족하여야 한다. 오늘날 정도, 규석 등 자연 소재로 만든 기존의 도자기와 구별하기 위하여 파인세라믹(혹은 첨단세라믹)이라고 불리운다. 파인 세라믹스는 정밀한 정제, 합성된 원료분말을 사용하며, 성형 및 소결이 정밀하게 제어된다.

Ceramics are used in electronics and other high-tech industries, so they must meet highly precise specifications and demanding performance requirements. Today, they are called Fine Ceramics (also known as "advanced ceramics") to distinguish them from conventional ceramics made from natural materials, such as clay and silica rock. Fine Ceramics are carefully engineered materials in which the chemical composition has been precisely adjusted using refined or synthesized raw powder, with a well-controlled method of forming and sintering.

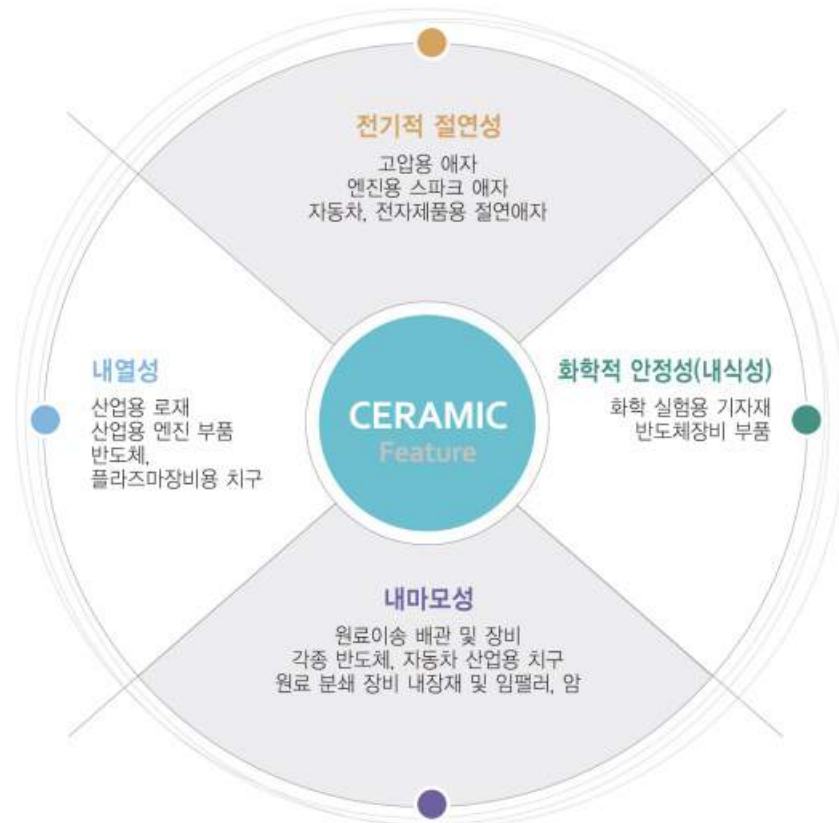

04 05

Business area⁺

We will try until the best leader in the field of ceramics for our customer's satisfaction through quality improvement and research and development.

01 세라믹 분말 프레스 (Ceramic Press Forming Part)

01. 분말가압성형 Powder Press Forming

비교적 단순하고, 소형이며 대량생산에 적합한 자동차, 기계, 의료장비 등의 고온, 내마모, 절연부품 생산
 It used to comparatively simple and small of high temperature, abrasion resistant parts for automobile, machine and medical parts in high-volume mass production

Applications
 Pump Parts / Patch Antenna / Ceramic Nozzle / Ceramic Gear, Disk, Shaft

02. 냉간정수압성형 CIP : Cold Isostatic Press

수압을 이용하여 전 방향에서 가압하여 고밀도의 제품 생산
 In Cold Isostatic Pressing (CIP) the powder is contained in a flexible mould, which is then immersed in a liquid, which is pumped to a high pressure. The most attractive thing about isostatic pressing is that the powder is compacted with the same pressure in all directions, high and uniform density can be achieved

Applications
 Ceramic bush, rad, cone types

02 세라믹 정밀가공 (Ceramic Machining & Lap-Polishing Part)

- 반도체, 플라즈마, 디스플레이 부품 Semiconductor, plasma, display appliances
 - 기계, 섬유, 자동차 등의 산업용 부품 Machine, textile, automobile appliances
 - 부식, 마모, 고온 등의 가혹한 환경에서도 물리, 화학적 특성이 변하지 않아 반도체 / 플라즈마 / 디스플레이장비의 핵심부품 및 기계 섬유 / 자동차 부품으로 Al_2O_3 , ZrO_2 , Si_3N_4 , SiC 등의 소재를 이용한 정밀가공 부품 생산
- From corrosion, abrasion, high temperature environment to can produce accuracy processing product of semiconductor, plasma, display and automobile parts using Al_2O_3 , ZrO_2 , Si_3N_4 and SiC material because physiotherapy and chemical special quality is stationary

Applications
 Ceramic Disk, Plate / Ceramic Pipe, Ring, Bush, Rod / Semiconductor Processing Equipment Parts
 Ceramic Chuck, Clamp, Stage / Plasma Discharge Electrodes Parts

03 내마모 세라믹 플랜트 (Wear-Resistant Ceramic Plant Part)

발전소, 제철소, 제지산업 등의 내마모 산업부품
 마모가 최대의 관건인 발전소, 제철소, 제지업 등의 원료이송라인에 기존 steel재료에 비해 10배 이상의 수명을 연장시킬 수 있는 내마모 설비부품 생산
 High abrasive resistant industrial parts for Power plants, steel mills, paper industry, etc.
 Production of abrasive resistant equipment parts to extend the life span 10 times or more longer than that of the existing steel materials on conveyor line for raw materials at Power plants, steel mills, paper industry, etc which are the most important in abrasive resistance.

Applications
 Wear-Resistant Ceramic Pipe, Elbow, Cone / Shock-Resistant Ceramic Composites Chute Liner / Ceramic Coated Roller, Mixer
 Ceramic Ball Valve / Ceramic-Rubber Adhesive Roller of Conveyor / Classifier Cyclone for Desulfurization System

주요제품
Main Product

산업기계, 환경플랜트 제작 및 설치

설비기계



모터샤프트 조립



사이클론 엘보 작업 원료



사이클론 탱크 8대



교반기 2대/ 침강조/ 무화조 8대



집수조 탱크



무화조 탱크 2대

실적사진



E/RAIL 냉간 인발 SYSTEM



E/RAIL 냉간 인발 SYSTEM

06

07



ROLLER & CHAIN CONVEYOR SYSTEM



ROLLER & CHAIN CONVEYOR SYSTEM



자동조립 SYSTEM



건조 Line (Booth & Duct)



화훼 영상 선별 SYSTEM



화훼 영상 선별 SYSTEM



UV Coating SYSTEM



BAG FILTER



HEAT EXCHANGER



HEAT EXCHANGER

주요제품
Main Product

산업기계, 환경플랜트 제작 및 설치

▣ 제작사진



대한페이퍼텍 소각설비(15TON/일)



오산발전소 소각설비



재처리기



제천시 소각설비SDA



남양공업 CHP CONVEYOR



SCREW CONVEYOR



담양군청 재활용 선별작업대



담양군청 재활용 선별작업대



신대양제지 T,R,S및 CYCLONE



신대양제지 T,R,S및 CYCLONE



동원제지 소각설비 (120ton/일)



동원제지 소각설비 (120ton/일)



한국환경개발 소각설비 (100ton/일)



한국환경개발 소각설비 (100ton/일)



한국건설기술연구원 BAG FILTER, SCREUBBER



한국건설기술연구원 BAG FILTER, SCREUBBER



쓰리나인 집진설비 제작,설치



쓰리나인 집진설비 제작,설치

주요제품 Main Product

세라믹 분말 프레스 및 정밀가공 (Ceramic Press Forming Part & Machining & Lap-Polishing Part)

(주)신성씨앤피는 첨단세라믹 부품 및 산업용 부품에서 핵심이 되는 애플리케이션을 제공합니다.
Shin Sung C&P is a custom industrial ceramic product manufacturer of advanced ceramic components and industrial ceramic parts for key technical industrial applications.

1. 반도체, 플라즈마 세라믹 부품 Semiconductor, Plasma Ceramic Products

반도체, 플라즈마 부품, 세라믹 절연체, 세라믹 링 등 다양한 산업용 세라믹 부품
Semiconductor, plasma parts, end-effector, ceramic insulators, ceramic rings with many other industrial ceramic applications

2. 자동차 세라믹 부품 Automotive Ceramic Products

자동차용 엔진부품, 연료, 점화 시스템의 세라믹 부품
Ceramic engine components, fuel and ignition systems.

3. 일반 산업용 부품 General Industrial

제지, 연료, 유리, 펌프, 온도 조절 장치 및 기타 첨단 세라믹 응용 제품 등 다양한 산업용 부품
Ceramic manufacturers of components for a variety of industrial requirements including paper, fuel, glass, pump, thermostat controls and other advanced ceramic applications.

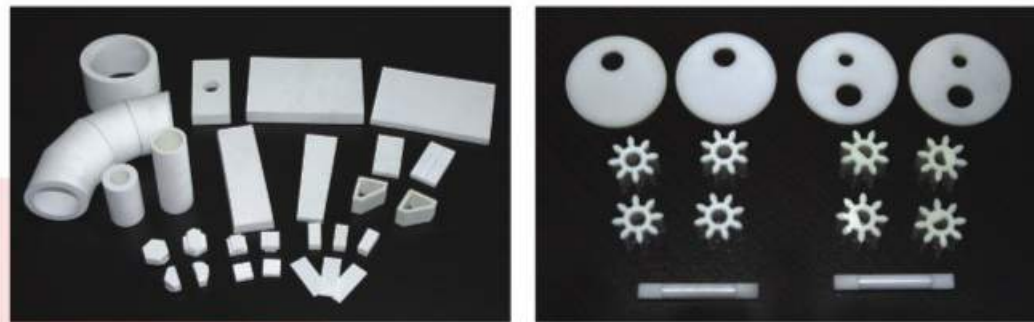

세라믹 분말 프레스 및 정밀가공 (Ceramic Press Forming Part & Machining & Lap-Polishing Part)

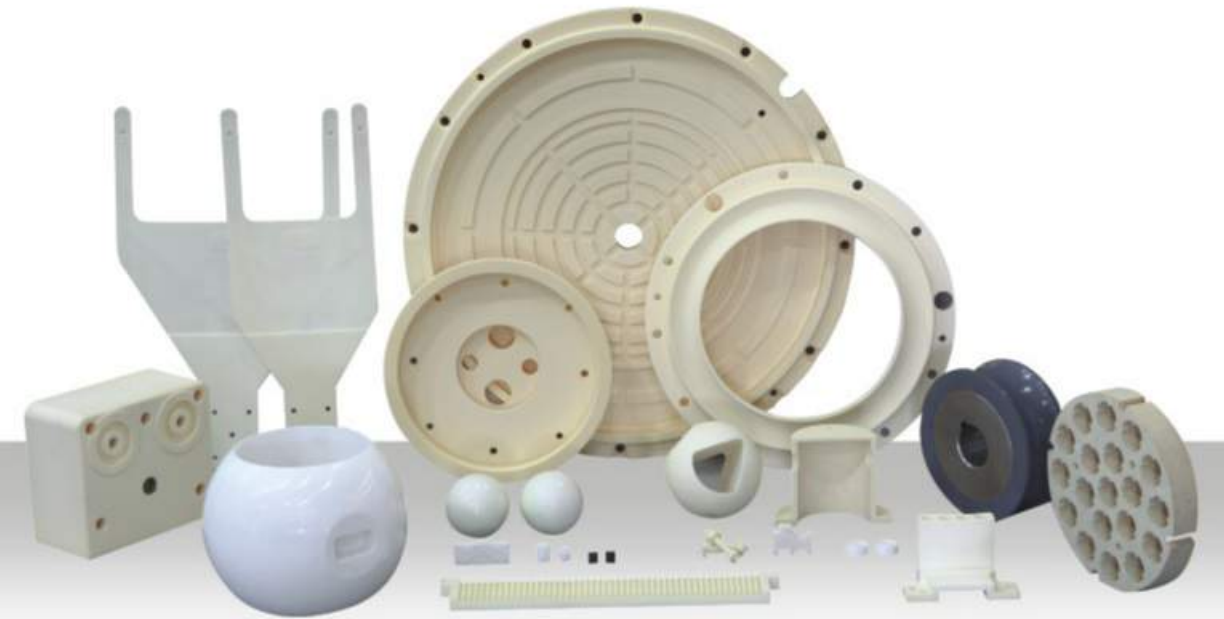

주요제품 Main Product

내충격 세라믹 복합재 슈트라이너 (Shock-Resistant Ceramic Composites Chute Liner)

화력발전소 등의 석탄취급설비계통에 사용되는 슈트라이너로 볼트가 용접된 스틸 케이스 내에 세라믹 부재를 구비, 내구성을 향상시켜 지속적인 석탄의 집중 낙하 및 충격에 쉽게 파손 및 이탈이 되지 않도록 고안된 제품
As chute Liner is used in coal handling equipment system, it equips ceramic parts in bolt welded steel case, so this item is designed to prevent coal from concentrated fall, easily breaking by impact & escaping from the route.



>> 특징 Feature

- 높은 내마모성을 갖는 CERAMIC TILE 소재 적용 advanced hard alumina ceramic wear-tiles
- 내충격성이 좋은 프레임 구조 적용 excellent shock resistant frame structure
- 시공 편의성을 극대화하기 위한 볼트체결 방식 easy to install - bolt types
- 매우 긴 수명 longest life available

>> 슈트라이너의 필요성 Chute Liner

화력 발전소에서 석탄의 이송에 사용되는 컨베이어 시스템은 고속으로 이동 하는 컨베이어벨트의 석탄이 Chute Case로 지속적인 강한 충격을 주며 강하하는데 충격에 대한 내마모성 및 내충격성이 높은 소재를 사용하여 파손을 예방함. → 이러한 역할을 Chute Liner가 담당하고 있음.

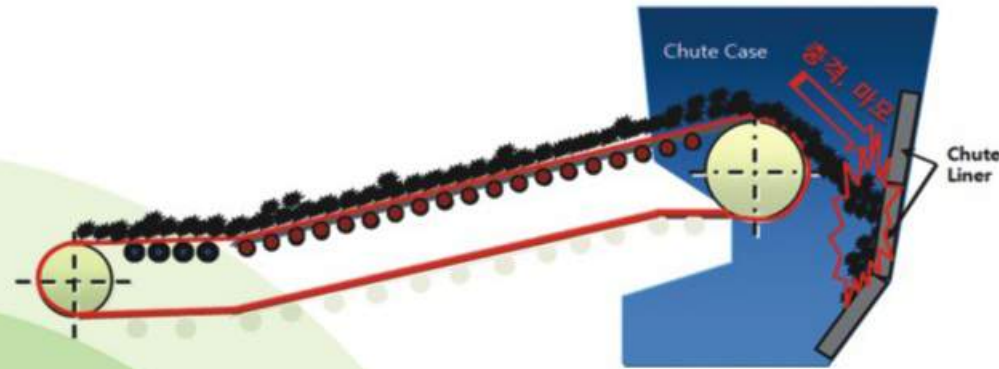

주요제품 Main Product

화력발전계통 탈황설비용 클래서파이어 사이클론 (Classifier Cyclone for Desulfurization System)

화력발전소 탈황설비에 사용되는 클래서파이어 사이클론으로 내부에 세라믹을 적용시켜 내마모성을 강화하여 수명연장 및 설비 운용의 효율성을 증대시킨 제품
As Classifier Cyclone is used for Desulfurization System at thermal power plant, it's designed to extend the life span & improve the efficiency of facilities management by strengthening the abrasive resistance after applying the ceramics inside.



>> 특징 Feature

- Stainless Steel 구조물 내에 Ceramic Inlet Head, Inlet Spiral, Cyclone의 순으로 장착됨
- 기존 폴리우레탄 수지에 비해 비교할 수 없는 정도의 매우 높은 내마모성과 수명을 지님
- It's installed with Ceramic Inlet Head, Inlet Spiral, Cyclone in order in stainless steel structure.
- It has very high abrasive resistance & long life span in unparalleled degree as compared with the existing polyurethane resin.



주요제품
Main Product

세라믹 볼밸브
(Ceramic Ball Valve)

고온, 내마모가 요구되는 이송라인에 사용
Used to Transfer lines in thermal protection and wear resistant part

>> 특징 Feature

Alumina, Zirconia Ball Type

>> 규격 Dimension

KS standard 10A~150A
기타 고객이 요구하는 규격의 설계 및 제작 가능
It's possible to design & manufacture the other sizes customers are requested for.

Applications

- ON-OFF Type
- Flow Control Type
- 2-way, 3-way ball valve



주요제품
Main Product

컨베이어벨트의 클리닝 장치
(Conveyor Belt Cleaner)

컨베이어벨트의 표면에 붙은 이물질을 제거하는 클리닝 장치
The cleaning device of conveyor belt surface for the remove impurities

>> 특징 Feature

가압 스프링 적용으로 블레이드의 접촉력을 증가, 마모율 감소 및 클리닝 효과를 높임
장치의 위치 조정이 가능하여 현장 설치가 용이함
Increasing the blade force, cleaning effect and reduces wear rates by applying pressure spring
The location of the device can be adjusted on-site easy to install

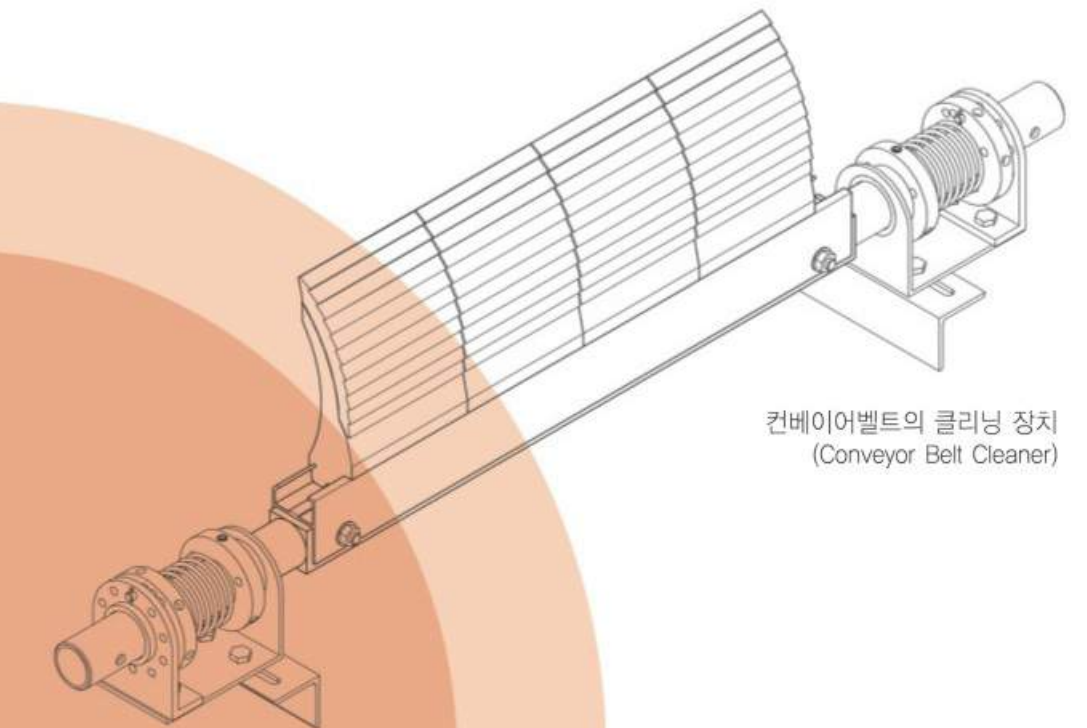
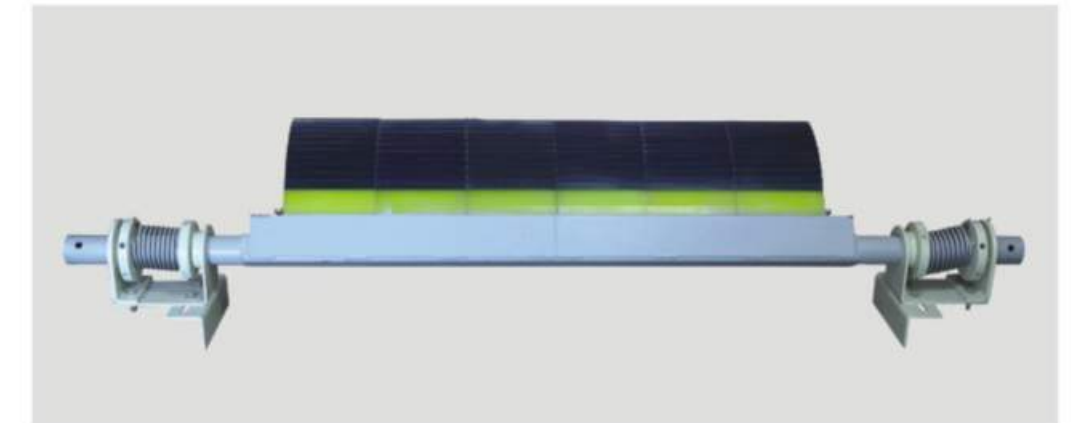

컨베이어벨트의 클리닝 장치
(Conveyor Belt Cleaner)

주요제품 Main Product

세라믹이 접착된 파이프, 엘보, 롤러 및 기타 플랜트류 (Ceramic lined Pipe, Elbow, Roller and plant systems)

발전소, 제철, 제지, 기타 산업용 내마모 이송라인에 적용
Used to Transfer lines in power plant, steel mills and paper industry

>> 특징 Feature

- 높은 경도, 내부식성, 고온안정성, 높은 내구성을 지님
- 일반 산업용 규격 파이프 내경 및 플랜치와 호환성
- 내마모 강판, 강관에 비해 가벼워 구조물의 경량화
- 미세한진동 및 충격 등에 쉽게 파손 및 탈락되지 않는 안정된 구조적 설계
- Stronger hardness, corrosion resistance, thermal protection and longer life expectancy
- Compatible with the general standard pipe and flanges
- Available in lightweight structures that wear lighter than steel
- Stable structural design without being damaged and derailed by minute vibration & shock.

>> 규격 Dimension

- KS standard 10A~250A Pipe, Elbow
- φ50 ~ φ350 x 1200L : Ceramic Roller
- 기타 고객이 요구하는 규격의 설계 및 제작 가능
- It's possible to design & manufacture the other sizes customers are requested for.



세라믹이 접착된 파이프, 엘보, 롤러 및 기타 플랜트류 (Ceramic lined Pipe, Elbow, Roller and plant systems)

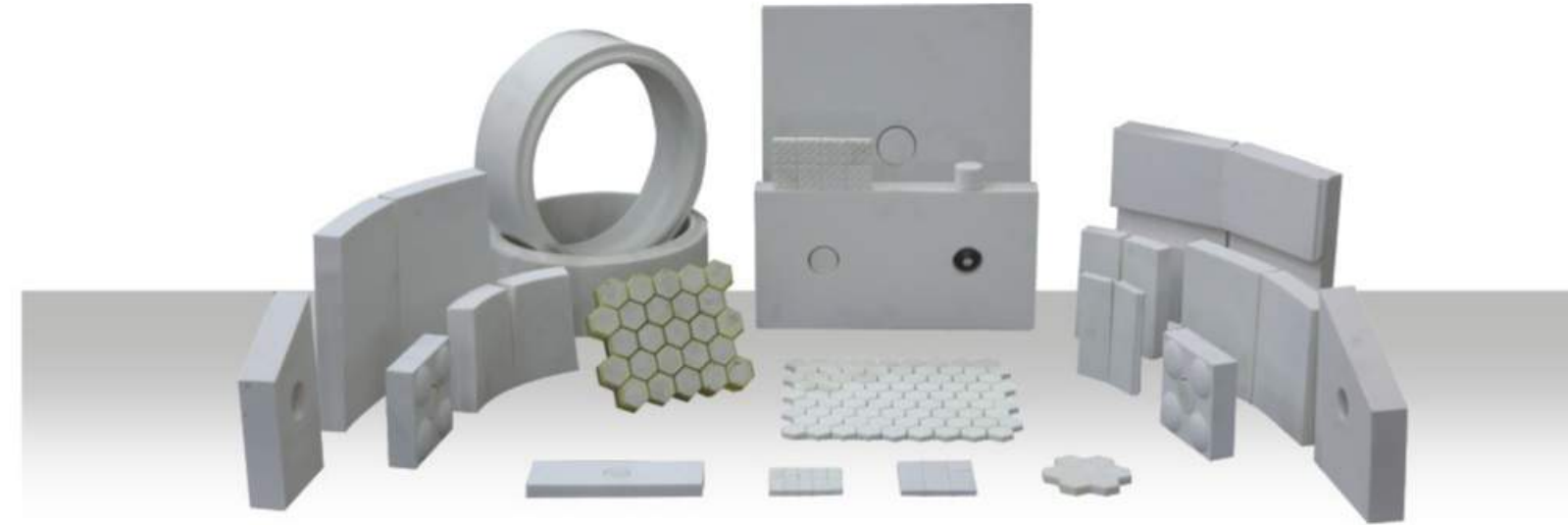

물성표 (Ceramic Properties Standard)

		Alumina		
Properties	Units	99.7%	96%	90%
Density	g/cm ³	3.9	3.6~3.7	3.6
Water Absorption	%	0	0	0
Color		IVORY	WHITE	WHITE
Vickers Hardness	Gpa	14.1	11.5	10.4
Flexural Strength	Mpa	380	350	340
Compressive Strength	40~1000℃ Mpa	2500	2,100~2,300	2,100~2,300
Fracture Toughness	Mpa m ^{1/2}	4.5	4	3.5
Coefficient of Thermal Expansion	1 X 10 ⁻⁶ /℃	8	8	8
Thermal Conductivity (20℃)	W/m °K	30	24	17
Thermal Shock Resistance	℃	200	250	250
Maximum Use Temp.	℃	1600	1600	1400
Delectric Strength	V/m	8.7 X 10 ⁻⁶	8.3 X 10 ⁻⁶	8.3 X 10 ⁻⁶
Volume Resistance	20℃	Ω-cm	>10 ¹⁴	>10 ¹⁴
	500℃	Ω-cm	2 X 10 ¹⁰	4 X 10 ⁹
	1000℃	Ω-cm	2 X 10 ⁶	1 X 10 ⁶
Delectric Constant	1 MHz	9.5	9	8.8
Delectric Loss (tan delta)	1 MHz	1 X 10 ⁻⁴	2 X 10 ⁻⁴	4 X 10 ⁻⁴

18 19

		Zirconia	Carbides	Nitrides					
		MgO Partially Stabilized Zirconia	Y2O3 Partially Stabilized Zirconia	Reaction Bonded Silicon Carbide	Direct Sintered Silicon Carbide	Silicon Nitride	Aluminum Nitride	Porcelain	Mullite
		5.7	6	3.1	3.1	3.2	3.3	2.4	2.8
		0	0	0	0	0	0	0	0
		IVORY	WHITE	BLACK	BLACK	BLACK	BLACK	WHITE	TAN
		11.8	12.7	26	26	14	11	5.9	7.4
		900	1240	460	480	-	-	130	170
		1750	2500	2700	3500	3800	3000	590	550
		11	13	4	4	-	-	2	2
		10	10	4.3	4.4	2.7	4.2	4.9	5.3
		2.2	2.2	125	150	30	160	50	3.5
		350	350	400	300	750	400	-	300
		500	1400	1000	1500	1200	1000	1300	1600
		9.4 X 10 ⁻⁶	9.0 X 10 ⁻⁶	-	-	-	-	-	9.8 X 10 ⁻⁶
		>10 ¹³	>10 ¹³	>10 ³	>10 ⁵	-	-	-	-
		2 X 10 ⁵	2X 10 ⁴	>10 ³	>10 ³	-	-	-	-
		2 X 10 ⁵	2X 10 ⁴	>10 ³	>10 ³	-	-	-	-
		>10 ³	>10 ³	>10 ³	>10 ³	-	-	5.9	6
		10 X 10 ⁻⁴	10 X 10 ⁻⁴	-	-	-	-	24 X 10 ⁻⁴	20 X 10 ⁻⁴